

Bollards

MIKO



LUMINAIRE

- Die-cast aluminium body (EN 47100).
- Extruded aluminium pole.
- Double layer polyester powder paint resistant to corrosion and salt spray fog.
- Silicone rubber gaskets.
- AISI 316 stainless steel external screws.
- PMMA lenses for LEDs.
- Screen made of 4mm thermal-shock resistant tempered glass.
- High quality LED sources characterized according to IES TM-30, with high color consistency <3SDCM and long useful life >60000 hours at L80.
- It complies with standards EN 60598-1 and EN 60598-2-1.

INSTALLATION

- Bollard installation.
- Die-cast aluminium base (EN 47100) for ground anchoring for rawlplugs.
- Supplied with IP66 socket-plug connector with locking ring for cables of diameter 9-12mm.

These fittings are suitable for the modern control systems. For the various possibilities, please see section "Controlling the light".

Different accessories to be ordered separately.

Also available in wall or urban version.

STANDARD PRODUCT		AVAILABLE OPTIONS
Wiring	ON/OFF (A)	
CCT	3000K (-830)	4000K (-840)
Colour	<input checked="" type="radio"/> 21	<input type="radio"/> 16



Photorealistic rendering.

Bollards

MIKO

ONEWAY





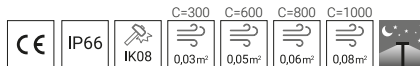
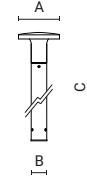

STANDARD COLOUR

● 21

DIMENSIONS



Code	Optic	Luminaire		CRI	CCT	Class	Wiring	Power Supply	A mm	B mm	C mm
		Watt	Lumen								
0872004A-830-21	 one way	10W	800lm	80	3000K	☐	ON/OFF	220-240V 50/60Hz	200	76	300
0872005A-830-21	 one way	10W	800lm	80	3000K	☐	ON/OFF	220-240V 50/60Hz	200	76	600
0872006A-830-21	 one way	10W	800lm	80	3000K	☐	ON/OFF	220-240V 50/60Hz	200	76	800
0872007A-830-21	 one way	10W	800lm	80	3000K	☐	ON/OFF	220-240V 50/60Hz	200	76	1000

 The **photo** represents the family product range. You can see the correct image of each product (code) on the website.

RADIAL





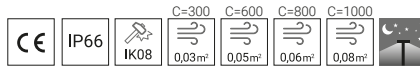
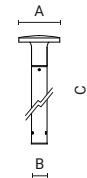

STANDARD COLOUR

● 21

DIMENSIONS



Code	Optic	Luminaire		CRI	CCT	Class	Wiring	Power Supply	A mm	B mm	C mm
		Watt	Lumen								
0872000A-830-21	 radial	20W	1700lm	80	3000K	☐	ON/OFF	220-240V 50/60Hz	200	76	300
0872001A-830-21	 radial	20W	1700lm	80	3000K	☐	ON/OFF	220-240V 50/60Hz	200	76	600
0872002A-830-21	 radial	20W	1700lm	80	3000K	☐	ON/OFF	220-240V 50/60Hz	200	76	800
0872003A-830-21	 radial	20W	1700lm	80	3000K	☐	ON/OFF	220-240V 50/60Hz	200	76	1000

LED driver included.

 **Available on request:**
 versions with CCT 2200K.

MIKO

ACCESSORIES

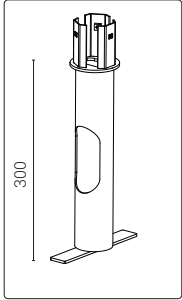

Code	Kg
1099334X	1,70

Zinc-coated steel pillar.

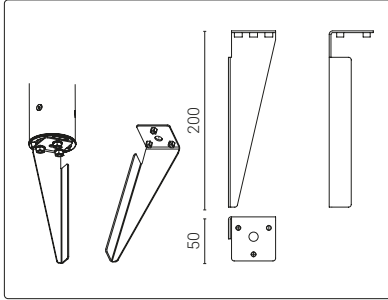

Code	Kg
1099339X	0,25

Zinc-coated steel spike.
ONLY for 300 mm tall bollards.

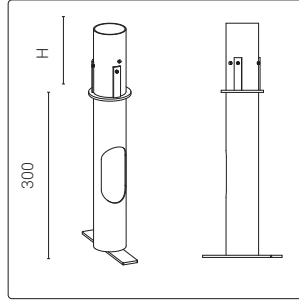

Code	H mm	Kg
1099335X (C=300)	124	1,50
1099336X (C=600)	424	2,30
1099337X (C=800)	624	2,90
1099338X (C=1000)	824	3,50

Zinc-coated steel basement for ground anchoring with a zinc-coated steel pole internal reinforcement.

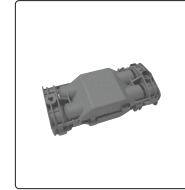

Code	Kg
1099259X	0,05

Junction box IP68 - 4 ways - 2/3 poles

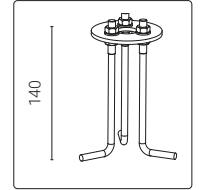

Code	Kg
1099396X-21	0,40

Galvanized and painted steel base plate with galvanized steel stud bolts.



Photorealistic rendering.