

Urban lighting

**MIKO** Grande



### LUMINAIRE

- Die-cast aluminium body (EN 47100).
- Double layer polyester powder paint resistant to corrosion and salt spray fog.
- Silicone rubber gaskets.
- AISI 316 stainless steel external screws.
- Wiring on removable galvanized steel tray.
- Driver protected against voltage surges.
- High quality LED sources characterized according to IES TM-30, with high color consistency <3SDCM and long useful life >60000 hours at L80.
- It complies with standards EN 60598-1 and EN 60598-2-3.

### INSTALLATION

- Post-top installation (Ø60mm or Ø76mm reduction).
- Supplied with power cable ended (0.15m) by IP66 socket-plug connector with locking ring for cables of diameter 9-12mm.

Available versions with Casambi and other modern control systems, for more information see "Light controls" section.

**Available wired with Zhaga Book 18 or NEMA ANSI C136.41 (5-pin) and waterproof cover.**

| STANDARD PRODUCT |                          | AVAILABLE OPTIONS                                  |  |
|------------------|--------------------------|--|--|
| Wiring           | ON/OFF (A)               | BIP (E), DALI (B)                                  |  |
| CCT              | 4000K (-840)             | 3000K (-830)                                       |  |
| Colour           | <input type="radio"/> 21 | <input type="radio"/> 12, <input type="radio"/> 16 |  |



Photorealistic rendering.

Urban lighting

# MIKO Grande









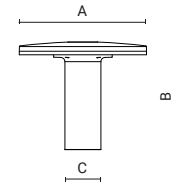



STANDARD COLOUR

 21

DIMENSIONS



| Code            | Optic   | Luminaire |        | CRI | CCT   | Class | Wiring | Power Supply     | A<br>mm | B<br>mm | C<br>mm |
|-----------------|---|-----------|--------|-----|-------|-------|--------|------------------|---------|---------|---------|
|                 |   | Watt      | Lumen  |     |       |       |        |                  |         |         |         |
| 0886002A-840-21 |  type II     | 30W       | 3400lm | 80  | 4000K | ☐     | ON/OFF | 220-240V 50/60Hz | 360     | 305     | 102     |
| 0886003A-840-21 |  type II     | 48W       | 5300lm | 80  | 4000K | ☐     | ON/OFF | 220-240V 50/60Hz | 360     | 305     | 102     |
| 0886004A-840-21 |  type III    | 30W       | 3600lm | 80  | 4000K | ☐     | ON/OFF | 220-240V 50/60Hz | 360     | 305     | 102     |
| 0886005A-840-21 |  type III    | 48W       | 5600lm | 80  | 4000K | ☐     | ON/OFF | 220-240V 50/60Hz | 360     | 305     | 102     |
| 0886006A-840-21 |  type IV    | 30W       | 3700lm | 80  | 4000K | ☐     | ON/OFF | 220-240V 50/60Hz | 360     | 305     | 102     |
| 0886007A-840-21 |  type IV   | 48W       | 5700lm | 80  | 4000K | ☐     | ON/OFF | 220-240V 50/60Hz | 360     | 305     | 102     |
| 0886008A-840-21 |  type IV-L | 30W       | 3600lm | 80  | 4000K | ☐     | ON/OFF | 220-240V 50/60Hz | 360     | 305     | 102     |
| 0886009A-840-21 |  type IV-L | 48W       | 5600lm | 80  | 4000K | ☐     | ON/OFF | 220-240V 50/60Hz | 360     | 305     | 102     |
| 0886000A-840-21 |  type VS   | 30W       | 3500lm | 80  | 4000K | ☐     | ON/OFF | 220-240V 50/60Hz | 360     | 305     | 102     |
| 0886001A-840-21 |  type VS   | 48W       | 5900lm | 80  | 4000K | ☐     | ON/OFF | 220-240V 50/60Hz | 360     | 305     | 102     |

 The **photo** represents the family product range. You can see the correct image of each product (code) on the website.

For post top mounting, check all available solutions on page 402.

**LED driver included.**

**Available on request:**  
 versions with Future-Proof, see pag.400.



Photorealistic rendering.

Urban lighting

# MIKO Grande

## ACCESSORIES

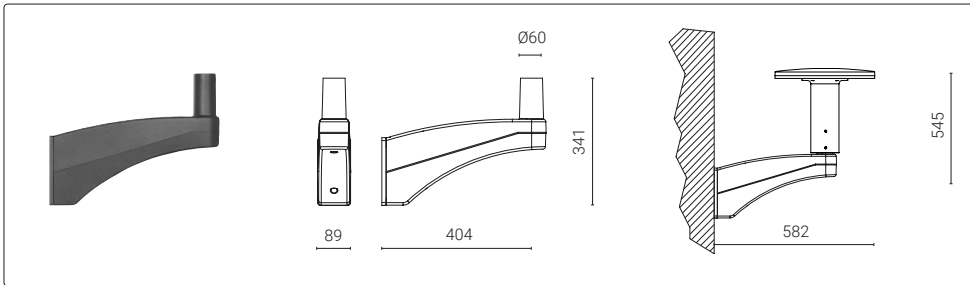

| Code | Kg |
|------|----|
|------|----|

|                    |      |
|--------------------|------|
| <b>1099098X-21</b> | 2,50 |
|--------------------|------|

Wall bracket.

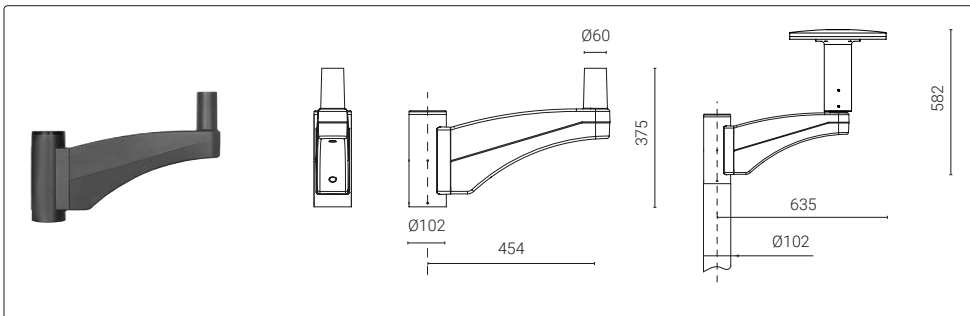

| Code | Kg |
|------|----|
|------|----|

|                    |      |
|--------------------|------|
| <b>1099097X-21</b> | 3,50 |
|--------------------|------|

Post-top mounting for single fixture for Ø 102 mm.

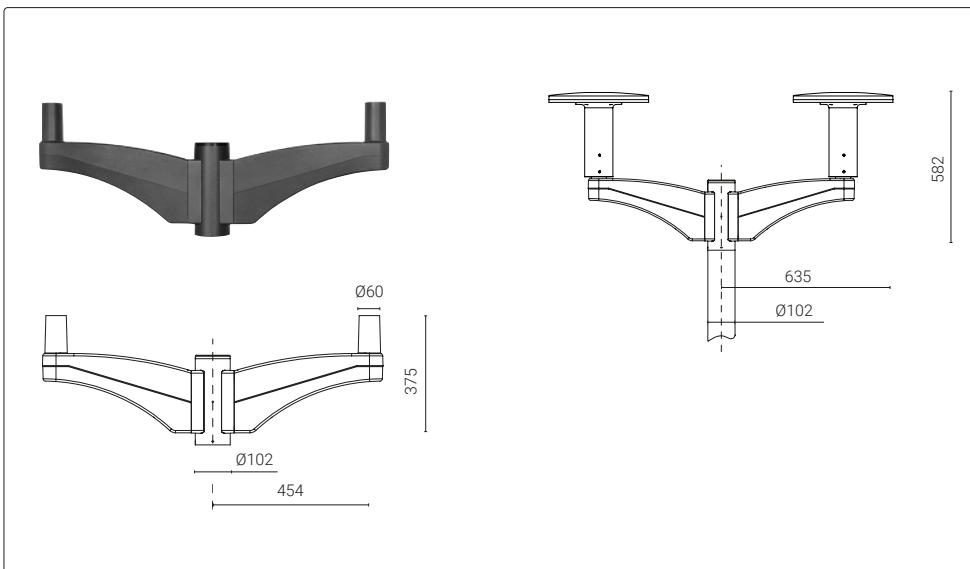

| Code | Kg |
|------|----|
|------|----|

|                    |      |
|--------------------|------|
| <b>1099096X-21</b> | 6,00 |
|--------------------|------|

Post-top mounting for double fixture for Ø 102 mm.



| Code | Kg |
|------|----|
|------|----|

|                    |      |
|--------------------|------|
| <b>1099566X-21</b> | 0,03 |
|--------------------|------|

Connecting ring and finishing ring for Ø60mm pole



| Code | Kg |
|------|----|
|------|----|

|                    |      |
|--------------------|------|
| <b>1099567X-21</b> | 0,05 |
|--------------------|------|

Connecting ring and finishing ring for Ø76mm pole

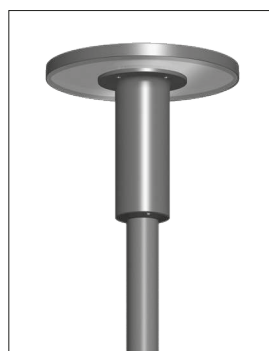

For post top mounting, check all available solutions on page 402.



Photorealistic rendering.

