

# Arianna Petrarca 2.0 LED Floodlight Installation Instructions

**Disclaimer:** The design features and layout drawings are subject to change without notice.

## Warning:

To ensure correct installation, follow these instructions. Keep these instructions after installing the product. This product must be installed by a qualified electrician or other authorised installer. There are no serviceable parts in this product. Return to the manufacturer for any repairs. Ensure the unit is not connected to the power during installation. During installation and maintenance do not touch the glass and the reflectors to prevent the deposit of dirt on them. Do not use if the power cord is damaged. This document is not subject to interpretation: if in doubt, contact the manufacturer.

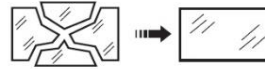
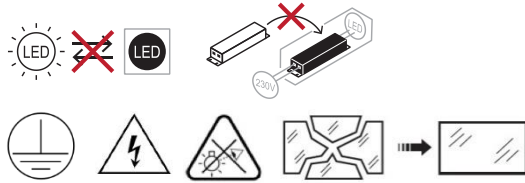

Damaged safety glass must be replaced by the manufacturer or their authorised re-sellers.

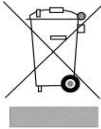

This symbol indicates that this product, once arrived at the end of life, should not be disposed with other household waste. Users must provide a separate collection. This behavior ensures that the equipment is treated properly contributing to the conservation of resources of the environment.



Do not stare at the operating light source. The luminaire should be positioned so that prolonged staring into the luminaire at a distance closer than 22m is not expected.



Caution, risk of electric shock. The light source contained in this luminaire shall only be replaced by the manufacturer, authorised service agent or a similar qualified person.

## GENERAL DATA:

Ingress protection: IP66  
Impact resistance: IK08 - 5J  
Electrical protection: CLASS I  
Suitable for indoor use  
Minimum distance to enlightened objects: 1m  
Compliance: CEI EN 60598-1, CEI EN 60598-2-5, IEC TR 62778  
Maximum installation height: 50m

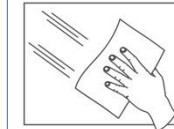

## MAINTENANCE:

Periodically perform surface cleaning, taking care not to use abrasive materials or substances in order to prevent its damage.

## OPTIONAL CABLE PROTECTION:

This document does not show the optional cable guard designed to protect wiring from birds and other wildlife. When cable guard is fitted, the installer should ensure cable is protected from birds at the connection point. Refer to spec sheet on adlt.com.au for more information.

## INTEGRATED DRIVER POWER CONNECTION | 4-6 MODULES PETRARCA + 2 INTEGRATED DRIVERS. NOTE: A 2.5m2 H07RN-F or H05RN-F cable (or equivalent) should be used. Flat cables are not acceptable.

Use a 2.5m2 H05RN-F or H07RN-F cable as power cable. Wire the power cable into the free terminals of the 3-way connector (the connector can be removed for easier installation).

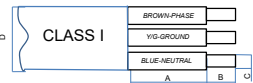

A	MAX 22 mm
B	8 mm
C	MIN 1.5 mm <sup>2</sup> MAX 2.5 mm <sup>2</sup> refer to local requirements
D	7+13.5 mm

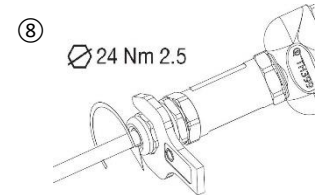
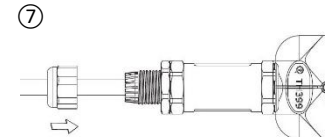
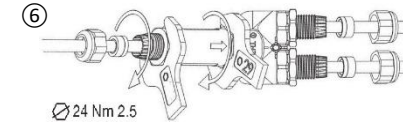
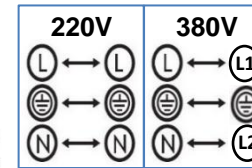
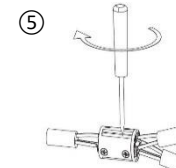
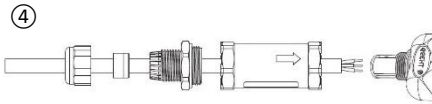
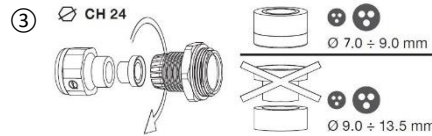
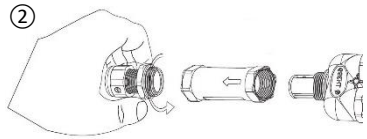
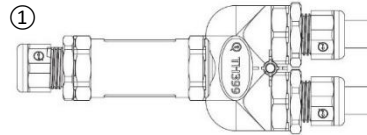

## INTEGRATED DRIVER POWER CONNECTION | 1-3 MODULES PETRARCA + 1 INTEGRATED DRIVER. NOTE: A 2.5m2 H07RN-F or H05RN-F cable (or equivalent) should be used. Flat cables are not acceptable.

Use a 2.5m2 H05RN-F or H07RN-F cable as power cable. Wire the power cable into the free terminals of the 2-way connector (the connector can be removed for easier installation).

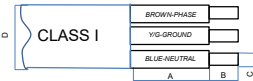

A	MAX 19 mm
B	6 mm
C	MIN 1.5 mm <sup>2</sup> MAX 4 mm <sup>2</sup> refer to local requirements
D	7+13.5 mm

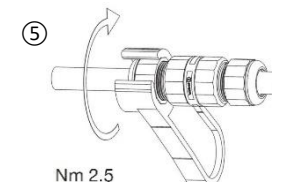
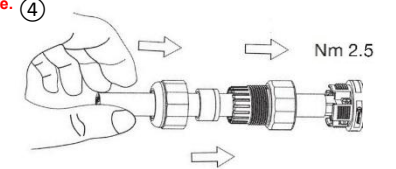
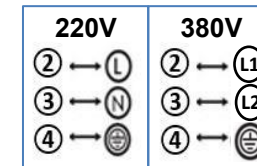
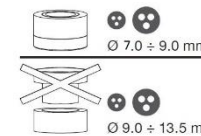
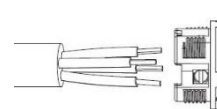
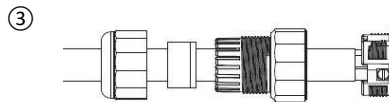
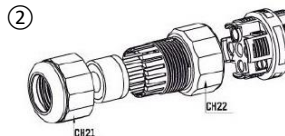
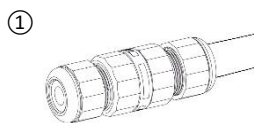

# Arianna Petrarca 2.0 LED Floodlight Installation Instructions

**Disclaimer:** The design features and layout drawings are subject to change without notice.

## 1 MODULE | DIMENSIONS

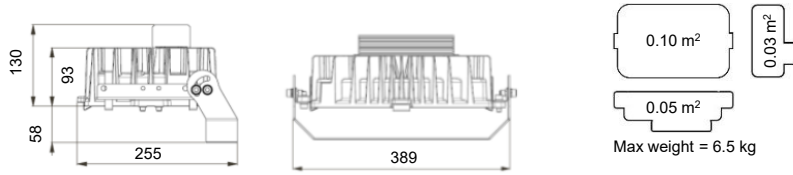

## 2 MODULES | DIMENSIONS

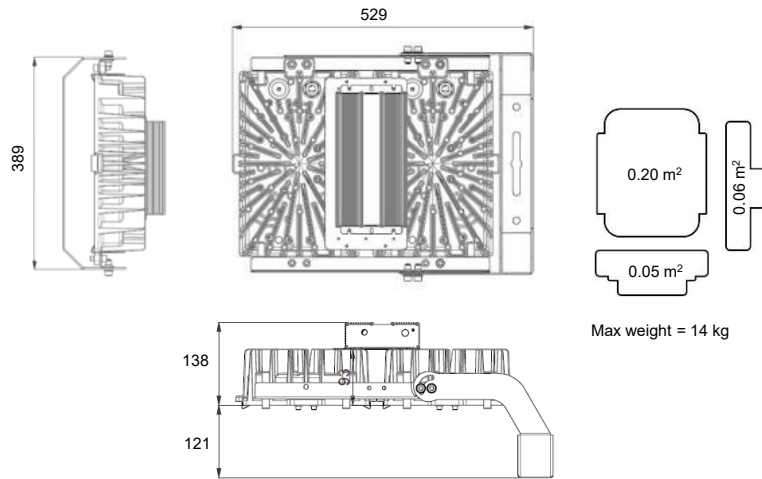

## 3 MODULE | DIMENSIONS

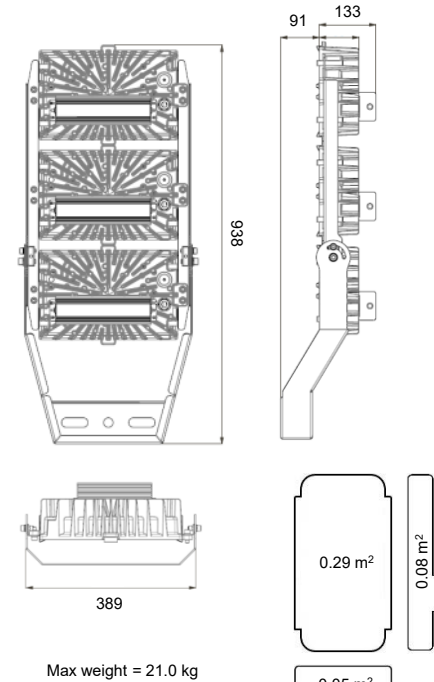

## 4 MODULE | DIMENSIONS

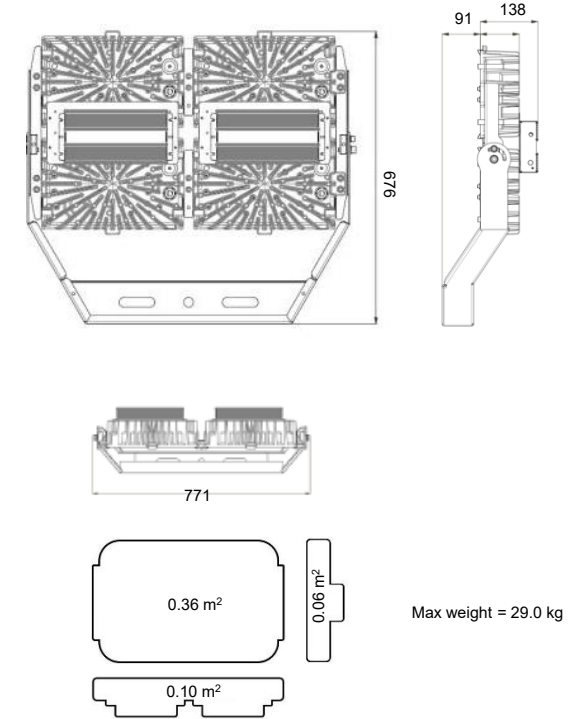

## 6 MODULES | DIMENSIONS

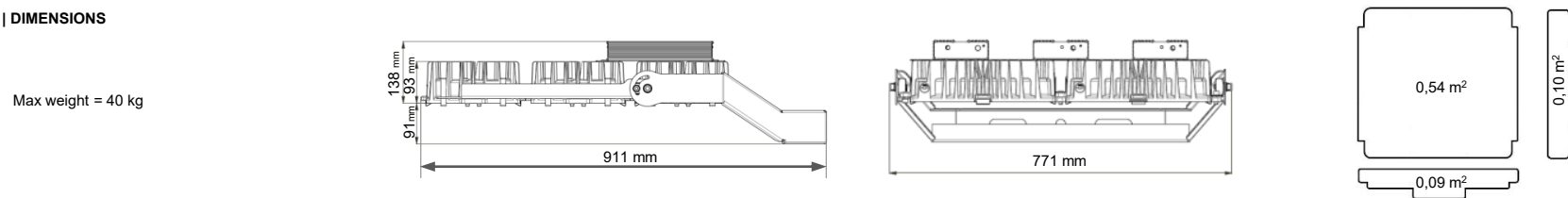

# Arianna Petrarca 2.0 LED Floodlight Installation Instructions

**Disclaimer:** The design features and layout drawings are subject to change without notice.

## 1 MODULE | BRACKET MOUNT

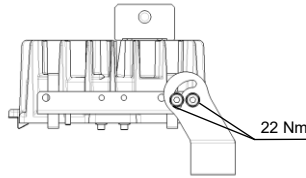
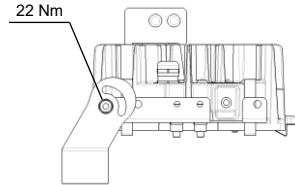
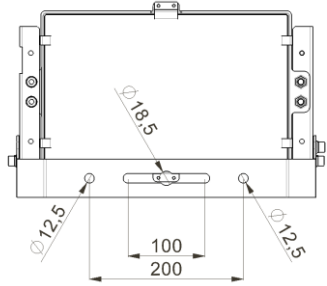

## 1 MODULE | WALL FIXING

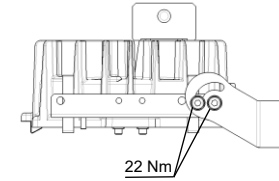

Tilt angle	
min	max
-20°	+90°

## 2 MODULES | BRACKET MOUNT

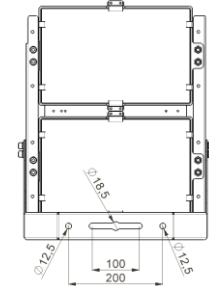
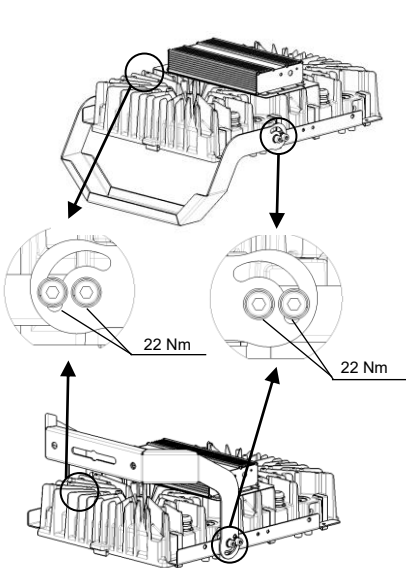

Tilt angle	
min	max
-20°	+100°

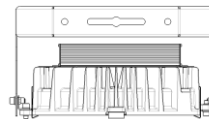

Tilt angle	
min	max
0°	+20°

## 2 MODULE | WALL FIXING

## 3 MODULES | BRACKET MOUNT

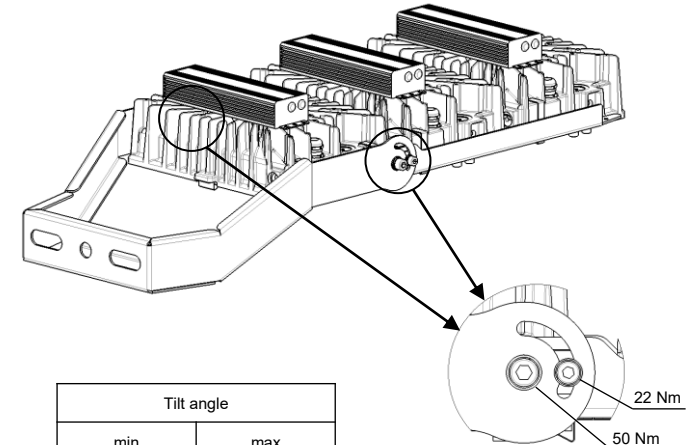
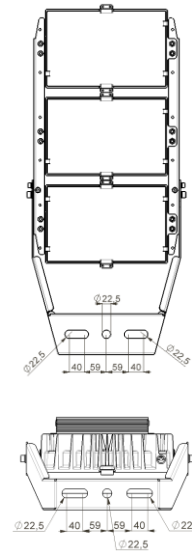

Tilt angle	
min	max
-25°	+90°

# Arianna Petrarca 2.0 LED Floodlight Installation Instructions

**Disclaimer:** The design features and layout drawings are subject to change without notice.

## 4 MODULES | BRACKET MOUNT

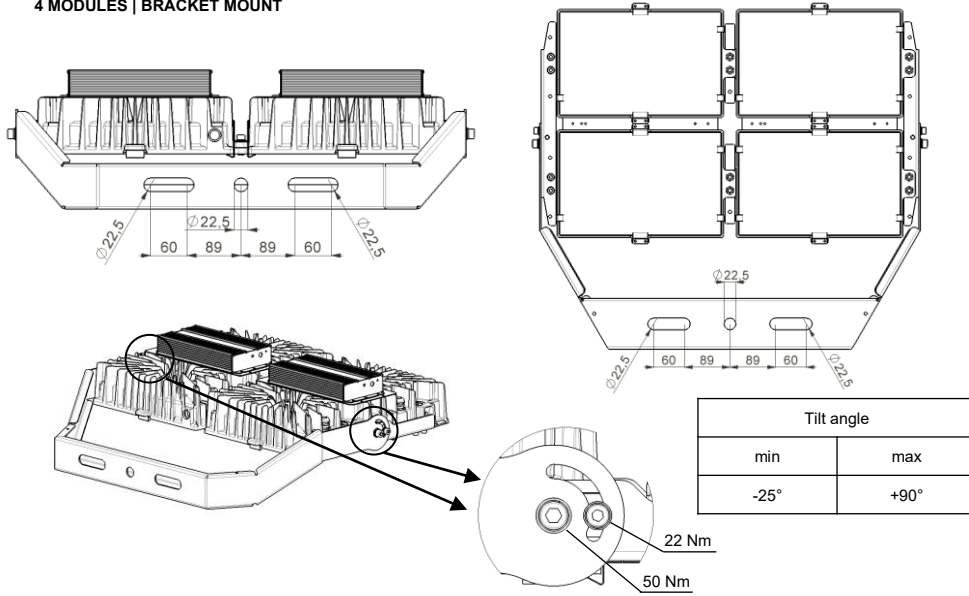

## 6 MODULES | BRACKET MOUNT

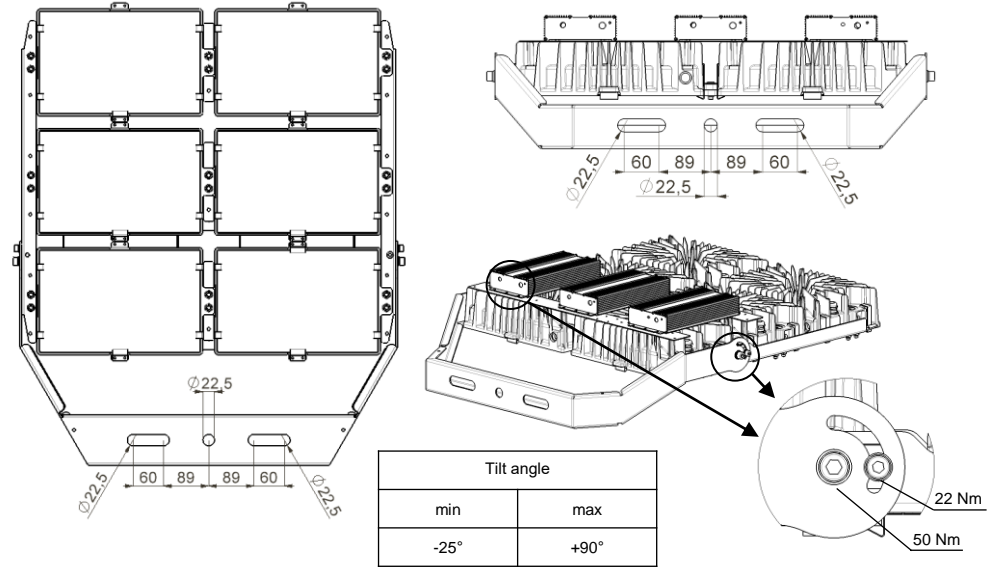

## OPERATING POSITION

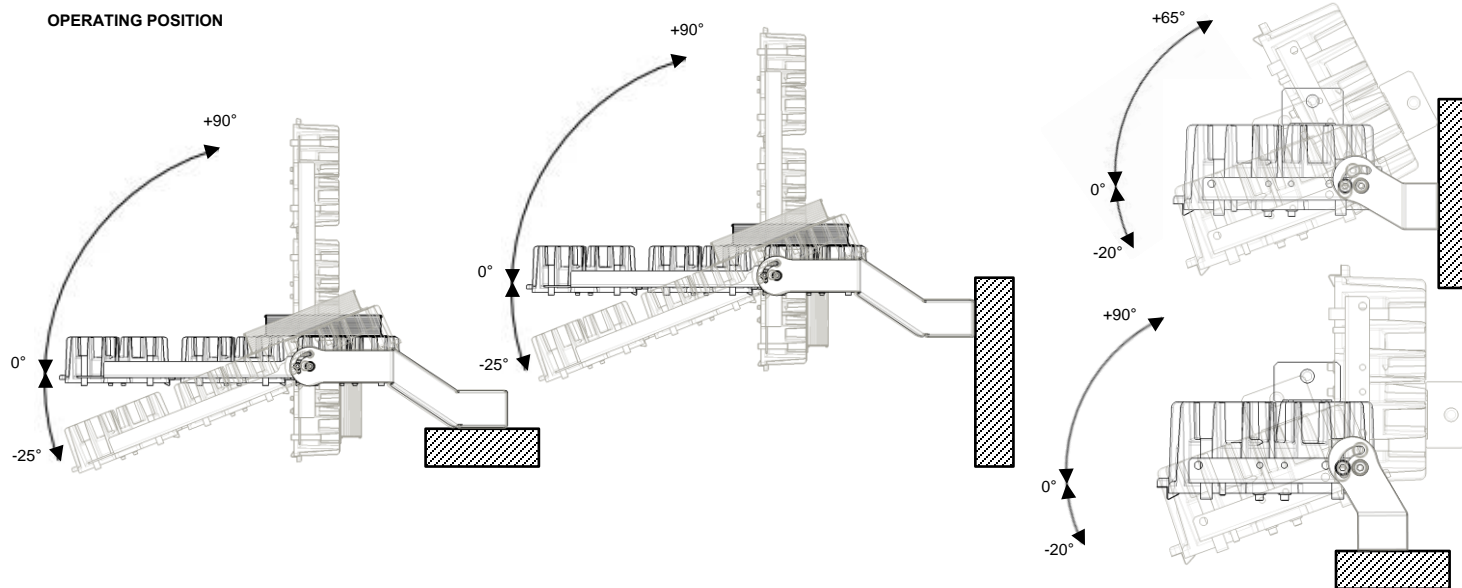

## IMPORTANT - OPERATING POSITIONS NOT ALLOWED

